



2024

PRODUCT

GUIDE





CONNECTING YOUR
OPERATION IN
EVERY SEASON

Ag Leader[®]



PRODUCTS & SERVICES



-  *pg.4* **Displays**
-  *pg.8* **Guidance & Steering**
-  *pg.10* **Planting**
-  *pg.12* **Application**
-  *pg.14* **Harvest**
-  *pg.16* **Water Management**
-  *pg.18* **Data Management**



YOUR FULL-FARM SOLUTION STARTS WITH THE INCOMMAND



Discover the perfect package for your operation by visiting agleader.com

DISPLAY FEATURE COMPARISON

InCommand 1200



InCommand 800



DISPLAY FEATURES	InCommand 1200	InCommand 800
Display Size	30.7 cm	21.3 cm
Split Screen	✓	
Headlands	✓	✓
Multiple Product Control	Up to 8	Up to 3
AutoSwath	✓	✓
Camera Support	4	4
AgFiniti & DisplayCast	✓	✓
Prescription Scaling	✓	✓
Remote Support	✓	✓
Guidance Only (upgradable)		✓
GUIDANCE & STEERING		
Lightbar Guidance	✓	✓
AutoSteer	✓	✓
StableLoc, GLIDE, SBAS (WAAS/EGNOS), TerraStar, RTK	✓	✓
SmartPath, Boundary Guidance	✓	✓
TurnPath	✓	✓
Tramlines & Access Paths	✓	✓
PLANTING/SEEDING		
Hybrid/Variety Logging	✓	✓
Variable Rate Planting	✓	✓
Planter Section Control (AutoSwath)	36 sections	36 sections
Split-Planter Logging	✓	✓
Planter Population Monitoring	✓	
Advanced Seed Monitoring	✓	
Hydraulic Down Force Logging	✓	
Row-by-Row Planter Performance	✓	
SureDrive, SureForce, Support	✓	
APPLICATION CONTROL		
Liquid Application Control		
DirectCommand L2 Liquid Section Control	36 sections	36 sections
RightSpot Individual Nozzle Control	144 nozzles	
ISOBUS Liquid Application Control	✓	✓
Boom Height Control	✓	✓
Droplet Size Monitoring	✓	✓
Pressure Fallback	✓	✓
Turn Compensation	✓	
NH3 Vapor State Monitoring	✓	✓
SmartReport	✓	
Dry Application Control		
Container Sequencing	✓	
Spinner Speed Control	✓	✓
Multi-Product Support	✓	✓
Strip-Till Application	✓	✓
SmartReport	✓	
YIELD MONITORING		
Grain Harvest	✓	✓
Harvest Variety Tracking & Mapping	✓	
CartACE	✓	✓
WATER MANAGEMENT		
Topography Mapping	✓	✓
Survey Collection	✓	✓
Intellislope Plough Control	✓	
ISOBUS		
Universal Terminal Support	✓	✓
Task Controller	✓	✓





InCommand[®]





THE POWERFUL DUO ALL CONNECTED

InCommand and AgFiniti work together to connect all your machines, displays and devices with the latest information across the farm.

- 

Sync all your displays and devices
- 

Live maps and stats from the field
- 

View displays remotely
- 

Display-to-display communication
- 

Multi-year analysis and queries
- 

Easily generate prescriptions
- 

Universal Terminal (ISOBUS) Compatibility
- 

Year-round functionality
- 

Split-screen capability
- 

Row-by-Row mapping
- 

Wireless connectivity across your farm





WORK MORE, STRESS LESS

From entry level to the most accurate steering system on the market, Ag Leader offers a solution for every operation.

Unmatched Steering Accuracy:



GPS 7000, GPS 7500:

Ag Leader offers a full range of GPS receivers, base stations and accuracy levels to fit your farm's needs.

	GLIDE	WAAS/EGNOS	TerraStar	RTK
GPS 7000	✓	✓	✓	
GPS 7500	✓	✓	✓	✓

TerraStar is unlockable with the GPS 7000.



SteadySteer:

SteadySteer provides autosteer for vehicles without a hydraulic steering valve. Simple integration and transferability are bonuses.



SteerCommand Z2:

SteerCommand Z2 provides integrated hydraulic steering directly to vehicle CAN bus, or hydraulic valve for leading autosteer performance.



SteerCommand with DualTrac:

Need to take it slow? DualTrac is a high accuracy, dual antenna steering solution for any speed on the farm, down to 0.08 km/h.



POWERFUL PLANTING TOOLS

Easily identify planter performance issues before they cost you yield in the field. Skips, doubles, singulation and more are quickly identified on the InCommand display.

Tools for Every Planter:



SureForce:

SureForce hydraulic downforce with uplift keeps your planter row unit at ideal planting depth, no matter the soil type, conditions or compaction.

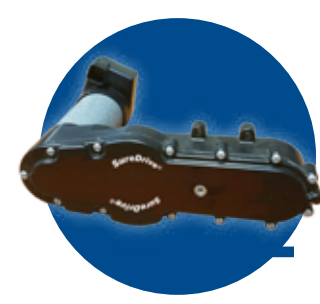

SureDrive:

SureDrive electric drives mount right up to the planter and meter you know and love, gaining you consistent meter drive for variable rate, turn compensation and point row shutoff - all with less maintenance.



SureStop:

Point row clutches such as SureStop offer one of the best returns for your precision ag investment. Save seed, save money.



APPLICATION TECHNOLOGY FOR EVERY FARM

The next generation of DirectCommand takes the complexity out of application with unmatched visibility through the InCommand display. Maximise the effectiveness of inputs with many options for precise application control.

The Right Set of Tools for Application:

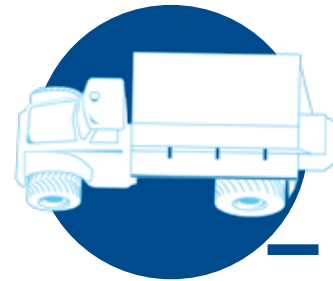

DirectCommand Granular:

Precisely control the application rate of dry products from your spinner spreader or strip-till applicator. Supports variable rate and multiple control channels for multi-product applications.



DirectCommand L2:

Controlled through the InCommand display, achieve variable rate and section control for your sprayer, NH3 applicator, or liquid fertiliser application. ISOBUS compatible controller also available.

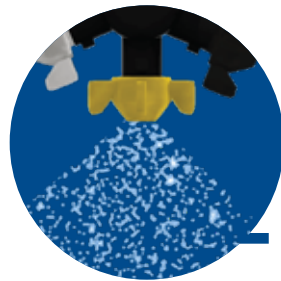

RightSpot:

Take your sprayer to the next level of accuracy and performance. Automatic nozzle-by-nozzle swath control and turn compensation ensure the right amount of spray reaches every part of your field. Independent rate and pressure control gives you the confidence and flexibility to operate in challenging terrain and maximise productivity.



Technology for Harvest:



Yield Monitor:

Ag Leader's technology started the data revolution with the first on-the-go monitor and today it's the most widely trusted yield monitor on the market. Easily see the areas of yield ranges in the field, load background maps of as planted varieties to track their performance or the effectiveness of an application trial or soil type.



TRUST NOTHING LESS THAN THE BEST

CartACE:

CartACE uses autosteer technology already within the operation to simplify the grain cart operators job. When it's time to unload, the grain cart engages with the press of a button and automatically steers on a line directly under the combine's auger. Autosteer takes over steering to assist operator with accurately unloading on the go.

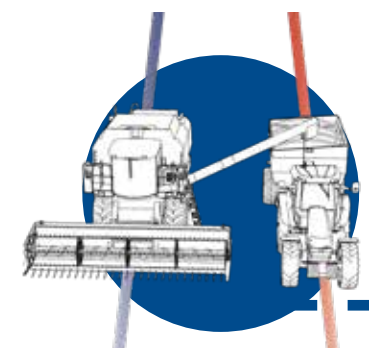

When it comes time for harvest, InCommand with AgFiniti connects your whole operation — across displays, devices and machines. See live field progress including maps and stats showing yield and moisture. Know the location of each machine and when it's time to unload.



Tools for Installing Field Tile:



DO-IT-YOURSELF TILE INSTALLATION

InCommand with Intellislope provides control and accuracy to confidently install field drainage tile on grade and without complicated laser equipment.

SMS Water Management Software:

Easily design field tile plans based on precise supporting RTK topography layers. Once the plan is complete, SMS will validate the plan to ensure desired drainage. Easily validate that tile runs are sized appropriately to meet drainage needs and ensure proper tile sizing using the Drainage Coefficient tool. The tool's velocity fail-safe ensures tile is laid on a grade-appropriate for the soil texture at the intended depth. Lastly, be sure you've created the best field tile plan by comparing multiple installation plans for cost and drainage efficiency.

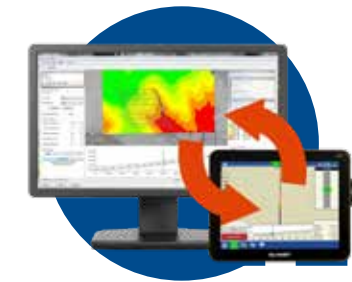

Intellislope:

With Intellislope and InCommand, installing field tile is super simple! First, collect a survey of the surface elevation by driving over the path either ahead of time or during installation. Then, enter parameters in the display that ensure tile is placed correctly in order to properly drain soils. Finally, use the plan you created to install your tile. AutoTile will adjust the plough depth automatically to ensure accurate installation.



Soil-Max Plough:

Intellislope pairs nicely with Soil-Max Gold Digger tile ploughs, a wholly-owned subsidiary of Ag Leader. You can learn more about their ploughs at soilmax.com.

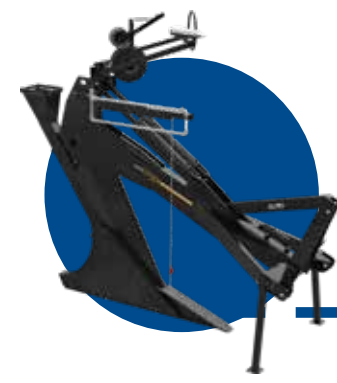



Powerful Tools to Discover Profit Opportunities:

SMS Software:

SMS Software supports the majority of precision ag display file types allowing you to combine and analyse all your data in one place. Powerful analysis tools allow you to dig deeper into your data and identify areas of opportunity including field and guidance line management, soil-sampling, prescriptions, tile planning and more. SMS pairs seamlessly with AgFiniti to allow you to take these insights with you to the field.

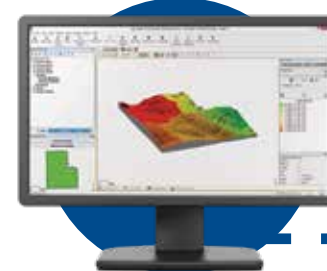

PLAN, PROFIT, MANAGE

Precision farming isn't about spending endless hours crunching numbers and analysing data. It's about answering questions that can make you more profitable. That's the simple idea behind Ag Leader's industry-leading data management tools: easy-to-use decision-making tools to help you capture the most out of every hectare.

AgFiniti:

AgFiniti connects your entire operation, including your displays and devices to share your information across your team, including trusted advisors. Access both historical and real-time information for on-the-go decision-making and insights into your fields. Quickly and easily generate prescriptions and dig deeper into your information using query tools, Multi-Year Analysis and Comparison Reports.



Ag Leader®



Ag Leader Technology, Inc. • 2202 S Riverside Dr, Ames, IA 50010 USA • agleader.com

Asia Pacific office • 25 Petrova Avenue, Windsor Gardens, South Australia
agleader.com.au • apsales@agleader.com



Ag Leader reserves the right to make changes in engineering, design and specifications, and improvements, or discontinue manufacture at any time without notice or obligation. AgFiniti®, Ag Leader®, Ag Leader Technology®, AutoTile®, CartACE®, DirectCommand®, DisplayCast®, DualTrac®, InCommand®, Intellislope®, SeedCommand®, SmartPath®, Soil-Max®, StableLoc®, SteadySteer®, SteerCommand® Z2, SureDrive®, SureForce®, SureStop® are registered trademarks of Ag Leader Technology Incorporated. AutoSwath™, RightSpot™, SmartReport™, SMS™ Software, TurnPath™ are trademarks of Ag Leader Technology Incorporated. Copyright © 2023 Ag Leader Technology Incorporated. All other marks are owned by their respective companies represented herein: Apple® iPad®, Apple Store®, TerraStar – NovAtel, Inc.