



2024

**PRODUCT
GUIDE**

**CONNECTING YOUR
OPERATION IN
EVERY SEASON**

Ag Leader[®]

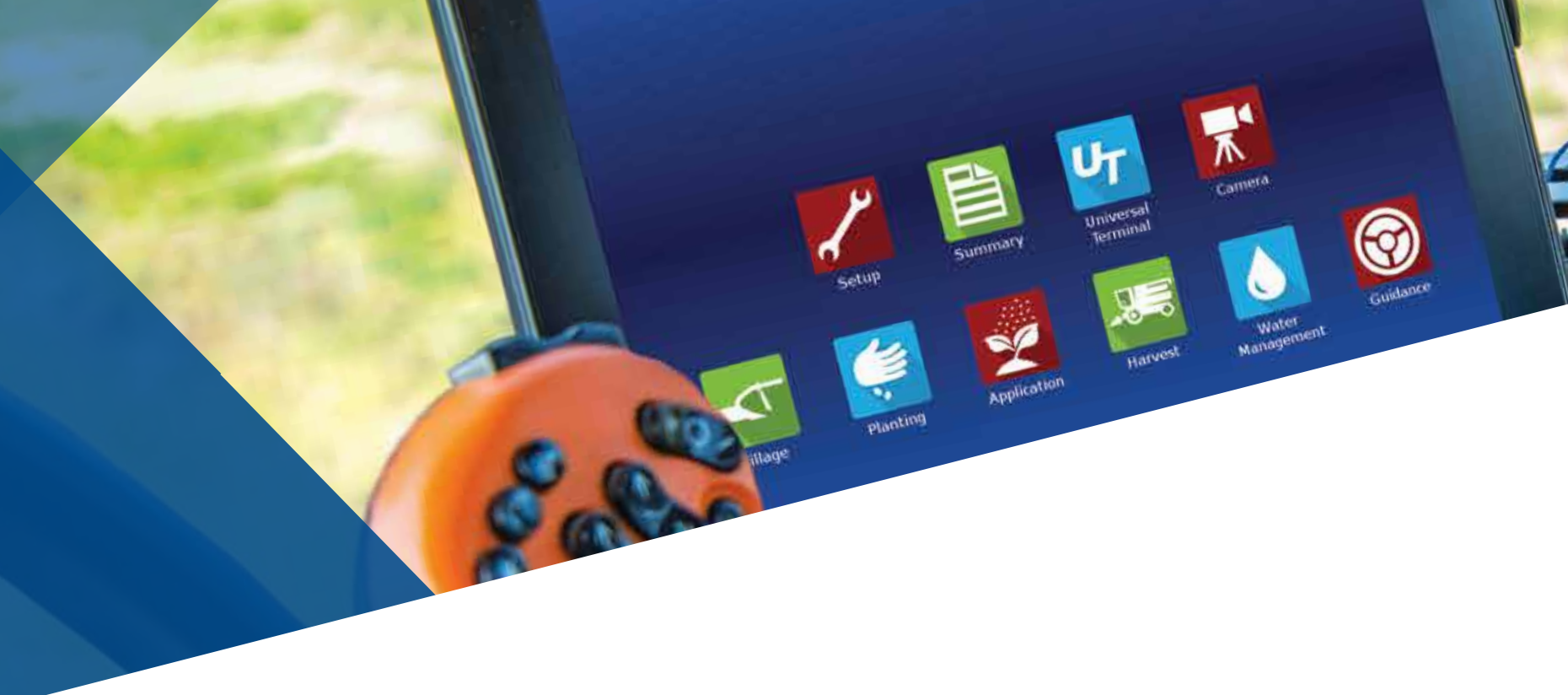

PRODUCTS & SERVICES



 *pg.4* **InCommand**

 *pg.8* **Guidance & Steering**

 *pg.10* **Planting**

 *pg.12* **Application**

 *pg.14* **Harvest**

 *pg.16* **Water Management**

 *pg.18* **Data Management**



CAB-TO-CAB. SEASON TO SEASON. STARTS WITH THE INCOMMAND



Discover the perfect package for your operation by visiting
agleader.com

DISPLAY FEATURE COMPARISON

InCommand 1200



InCommand 800



DISPLAY FEATURES	InCommand 1200	InCommand 800
Display Size	12.1"	8.4"
Split Screen	✓	
Headlands	✓	✓
Multiple Product Control	Up to 8	Up to 3
AutoSwath	144 Sections	144 Sections
Camera Support	4	4
AgFiniti & DisplayCast	✓	✓
Prescription Scaling	✓	✓
Remote Support	✓	✓
Guidance Only (upgradable)		✓
GUIDANCE & STEERING		
Lightbar Guidance	✓	✓
AutoSteer	✓	✓
StableLoc, GLIDE, SBAS (WAAS/EGNOS), TerraStar, RTK	✓	✓
SmartPath, Boundary Guidance	✓	✓
TurnPath	✓	✓
Tramlines & Access Paths	✓	✓
PLANTING/SEEDING		
Hybrid/Variety Logging	✓	✓
Variable Rate Planting	✓	✓
Planter Section Control (AutoSwath)	36 sections	36 sections
Split-Planter Logging	✓	✓
Planter Population Monitoring	✓	
Advanced Seed Monitoring	✓	
Hydraulic Down Force Logging	✓	
Row-by-Row Planter Performance	✓	
SureDrive, SureForce Support	✓	
APPLICATION CONTROL		
Liquid Application Control		
DirectCommand L2 Liquid Section Control	36 sections	36 sections
RightSpot Individual Nozzle Control	144 nozzles	
ISOBUS Liquid Application Control	✓	✓
Boom Height Control	✓	✓
Droplet Size Monitoring	✓	✓
Pressure Fallback	✓	✓
Turn Compensation	✓	
NH3 Vapor State Monitoring	✓	✓
SmartReport	✓	
Dry Application Control		
Container Sequencing	✓	
Spinner Speed Control	✓	✓
Multi-Product Support	✓	✓
Strip-Till Application	✓	✓
SmartReport	✓	
YIELD MONITORING		
Grain Harvest	✓	✓
Harvest Variety Tracking & Mapping	✓	
CartACE	✓	✓
WATER MANAGEMENT		
Topography Mapping	✓	✓
Survey Collection	✓	✓
Intellislope Plow Control	✓	
ISOBUS		
Universal Terminal Support	✓	✓
Task Controller	✓	✓



THE POWERFUL DUO ALL CONNECTED

InCommand and AgFiniti work together to connect all your machines, displays, and devices with the latest information across the farm.

Sync all your displays and devices

Live maps and stats from the field



Support displays remotely

Display-to-display communication

Multi-year analysis and queries

Easily generate prescriptions



Year-round functionality

Split-screen capability

Row-by-row mapping

Wireless connectivity across your farm

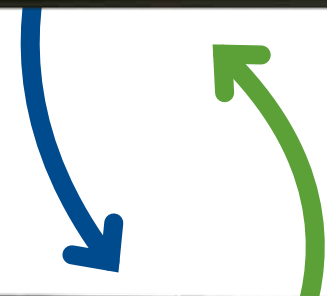
InCommand[®]





Unmatched Steering Accuracy

GPS 7000, GPS 7500

Ag Leader offers a full range of GPS receivers, base stations, and accuracy levels to fit your farm's needs.



	GLIDE	WAAS/EGNOS	TerraStar	RTK
GPS 7000	✓	✓	✓	
GPS 7500	✓	✓	✓	✓

TerraStar is unlockable with the GPS 7000.

SteadySteer

SteadySteer provides autosteer for vehicles without a hydraulic steering value. Simple integration and transferability are bonuses.



SteerCommand Z2

SteerCommand Z2 provides integrated hydraulic steering directly to vehicle CAN bus or hydraulic valve for leading autosteer performance.



SteerCommand with DualTrac

Need to take it slow? DualTrac is a high-accuracy, dual-antenna steering solution for any speed on the farm, down to 0.05 MPH.



WORK MORE, STRESS LESS

From entry level, up to the most accurate steering system on the market, Ag Leader offers a solution for every operation.



Tools for Every Planter



POWERFUL PLANTING TOOLS

Easily identify planter performance issues before they cost you yield in the field. Skips, doubles, singulation, and more are quickly identified on the InCommand display.



SureForce

SureForce hydraulic downforce with uplift keeps your planter row unit at ideal planting depth, no matter the soil type, conditions, or compaction.



SureDrive

SureDrive electric drives mount right up to the planter and meter you know and love, gaining you consistent meter drive for variable rate, turn compensation, and point row shutoff - all with less maintenance.



SureStop

SureStop electric row clutches turn planter sections on and off row-by-row using low-maintenance, easy-to-install, automatic row shutoffs. Save seed; save money.



The Right Set of Tools for Application



APPLICATION TECHNOLOGY FOR EVERY FARM

The next generation of DirectCommand takes the complexity out of the application with unmatched visibility through the InCommand display. Maximize the effectiveness of inputs with many options for precise application control.



DirectCommand Granular

Precisely control the application rate of dry products from your spinner spreader or strip-till applicator. Supports variable rate and multiple control channels for multi-product applications.

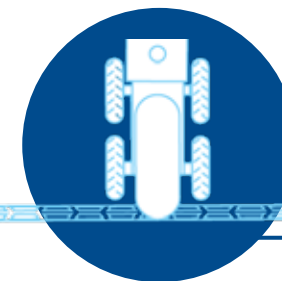

DirectCommand L2

Controlled through the InCommand display, achieve variable rate and section control for your sprayer, NH3 applicator, or liquid fertilizer application. ISOBUS compatible controller also available.

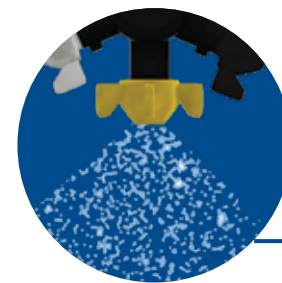

RightSpot

Take your sprayer to the next level of accuracy and performance. Automatic nozzle-by-nozzle swath control and turn compensation ensure the right amount of spray reaches every part of your field. Independent rate and pressure control gives you the confidence and flexibility to operate in challenging terrain and maximize productivity.



Technology for Harvest



TRUST NOTHING LESS THAN THE BEST

When it comes time for harvest, InCommand with AgFiniti connects your whole operation — across displays, devices, and machines. Know live field progress including maps and stats showing yield and moisture. Know the location of each machine and when it's time to unload.



Yield Monitor

Ag Leader's technology started the data revolution with the first on-the-go monitor and it remains the most widely trusted yield monitor on the market. Easily see the areas of the yield ranges in the field, load background maps of as-planted varieties to track their performance or the effectiveness of an application trial or soil type.

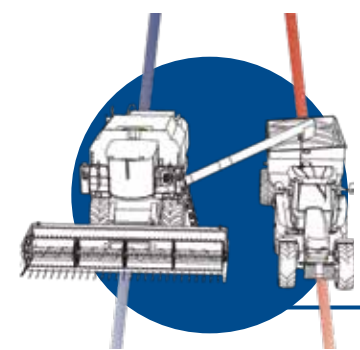

CartACE

CartACE uses autosteer technology already within the operation to simplify the grain cart operator's job. When it's time to unload, the grain cart engages with the press of a button and automatically steers on a line directly under the combine's auger. Autosteer takes over steering to assist the operator with accurately unloading on the go.



Tools for Installing Field Tile

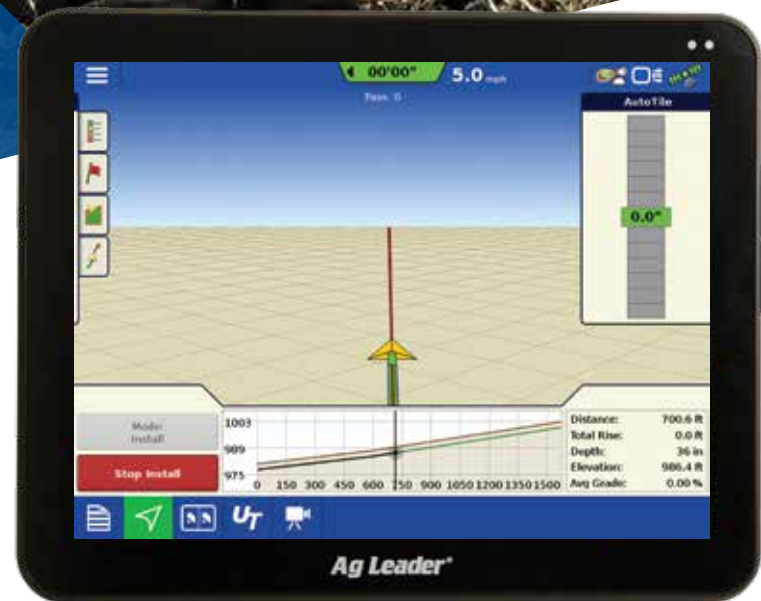

DO-IT-YOURSELF TILE INSTALLATION

InCommand with Intellislope provides control and accuracy to confidently install field drainage tile on grade and without complicated laser equipment.

SMS Water Management Software

Easily design field tile plans based on precise RTK topography layers. Once the plan is complete, SMS will validate the plan to ensure desired drainage. Easily validate that tile runs are sized appropriately to meet drainage needs and ensure proper tile sizing using the Drainage Coefficient tool. The tool's velocity fail-safe ensures tile is laid on a grade-appropriate for the soil texture at the intended depth. Lastly, be sure you've created the best field tile plan by comparing multiple installation plans for cost and drainage efficiency.

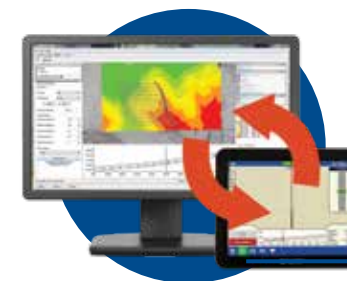

Intellislope

With Intellislope and InCommand, installing field tile is super simple! First, collect a survey of the surface elevation by driving over the path either ahead of time or during installation. Then, enter parameters in the display that ensure tile is placed correctly to properly drain soils. Finally, use the plan you created to install your tile. AutoTile will adjust the plow depth automatically to ensure accurate installation.



Soil-Max Plow

Intellislope pairs nicely with Soil-Max Gold Digger tile plows, a wholly-owned subsidiary of Ag Leader. You can learn more about their plows at soilmax.com.





Powerful Tools to Discover Profit Opportunities



SMS Software

SMS Software supports the majority of precision ag display file types, allowing you to combine and analyze all your data in one place. Powerful analysis tools allow you to dig deeper into your data and identify areas of opportunity including field and guidance line management, soil sampling, prescriptions, tile planning, and more. SMS pairs seamlessly with AgFiniti, so you can take these insights to the field.

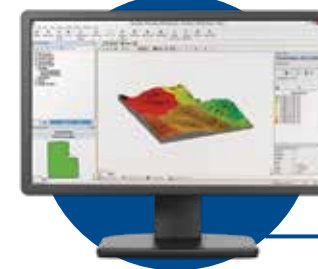

PLAN IT, MANAGE IT, PROFIT

Precision farming isn't about spending endless hours crunching numbers and analyzing data. It's about answering questions that can make you more profitable. That's the simple idea behind Ag Leader's industry-leading data management tools: easy-to-use decision-making tools to help you capture the most out of every acre.

AgFiniti

AgFiniti connects your entire operation including your displays and devices, so you can share information with your team, including trusted advisors. Access both historical and real-time information for on-the-go decision making and insights into your fields. Quickly and easily generate prescriptions and dig deeper into your information using query tools, Multi-Year Analysis, and Comparison Reports.



Ag Leader®

To learn about our full suite of products or to find your local Ag Leader dealer, scan the QR code below.



Ag Leader Technology, Inc. • 2202 S Riverside Dr, Ames, IA 50010 USA • agleader.com



Ag Leader reserves the right to make changes in engineering, design and specifications, and improvements, or discontinue manufacture at any time without notice or obligation. AgFiniti®, Ag Leader®, Ag Leader Technology®, AutoTile®, CartACE®, DirectCommand®, DisplayCast®, DualTrac®, InCommand®, Intellislope®, SeedCommand®, SmartPath®, Soil-Max®, StableLoc®, SteadySteer®, SteerCommand® Z2, SureDrive®, SureForce®, SureStop® are registered trademarks of Ag Leader Technology Incorporated. AutoSwath™, RightSpot™, SmartReport™, SMS™ Software, TurnPath™ are trademarks of Ag Leader Technology Incorporated. Copyright © 2023 Ag Leader Technology Incorporated. All other marks are owned by their respective companies represented herein: Apple® iPad®, Apple Store®, TerraStar – NovAtel, Inc.